

### FEATURES

- Complete rate gyroscope on a single chip
- Z-axis (yaw-rate) response
- High vibration rejection over wide frequency
- 2000 g powered shock survivability
- Self-test on digital command
- Temperature sensor output
- Precision voltage reference output
- Absolute rate output for precision applications
- 5 V single-supply operation
- Ultra small and light (< 0.15 cc, < 0.5 gram)

### APPLICATIONS

- GPS navigation systems
- Image stabilization
- Inertial measurement units
- Platform stabilization

### GENERAL DESCRIPTION

The ADXRS401 is a functionally complete and low cost angular rate sensor (gyroscope), integrated with all of the required electronics on one chip. It is manufactured using Analog Devices' surface-micromachining technique, the same high volume BIMOS process used for high reliability automotive airbag accelerometers. It is available in a 7 mm × 7 mm × 3 mm BGA surface-mount package.

The output signal, RATEOUT (1B, 2A), is a voltage proportional to angular rate about the axis normal to the top surface of the package (see Figure 2). A single external resistor can be used to lower the scale factor. An external capacitor is used to set the bandwidth. Other external capacitors are required for operation (see Figure 1).

A precision reference and a temperature output are also provided for compensation techniques. Two digital self-test inputs electromechanically excite the sensor to test proper operation of both sensors and the signal conditioning circuits.

### FUNCTIONAL BLOCK DIAGRAM

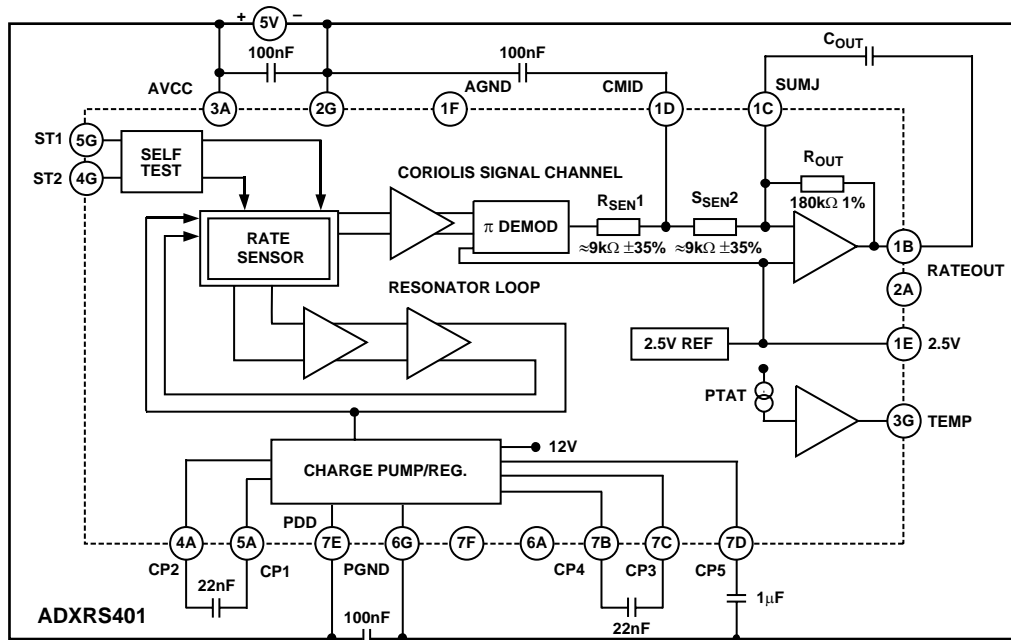

Figure 1.

### Rev. 0

Information furnished by Analog Devices is believed to be accurate and reliable. However, no responsibility is assumed by Analog Devices for its use, nor for any infringements of patents or other rights of third parties that may result from its use. Specifications subject to change without notice. No license is granted by implication or otherwise under any patent or patent rights of Analog Devices. Trademarks and registered trademarks are the property of their respective owners.

## TABLE OF CONTENTS

Specifications.....	3
Absolute Maximum Ratings.....	4
Rate-Sensitive Axis .....	4
Pin Configuration and Function Descriptions.....	5
Typical Performance Characteristics .....	6
Theory of Operation .....	8
Supply and Common Considerations .....	8
Setting Bandwidth .....	9
Increasing Measurement Range .....	9
Temperature Output and Calibration .....	9
Use with a Supply-Ratiometric ADC.....	10
Null Adjust.....	10
Self-Test Function.....	10
Acceleration Sensitivity .....	10
Outline Dimensions .....	12
Ordering Guide.....	12

## REVISION HISTORY

7/04—Revision 0: Initial Version

## SPECIFICATIONS

@T<sub>A</sub> = 25°C, V<sub>s</sub> = 5 V, bandwidth = 80 Hz (C<sub>OUT</sub> = 0.01 μF), angular rate = 0°/s, ± 1 g, unless otherwise noted.

**Table 1.**

Parameter	Conditions	Min	Typ	Max	Unit
SENSITIVITY	Top view clockwise rotation is positive output				
Dynamic Range <sup>1</sup>	Full-scale range, –40°C to +85°C	±75			°/s
Scale Factor	–40°C to +85°C	12.75	15	17.25	mV/°/s
Nonlinearity	Best fit straight line		0.1		% of FS
NULL					
Initial Null			2.50		V
Turn-On Time	Power on to ± ½°/s of final		35		ms
Linear Acceleration Effect	Any axis		0.2		°/s/g
NOISE PERFORMANCE					
Rate Noise	@ 10 Hz bandwidth		3		mV (rms)
FREQUENCY RESPONSE					
3 dB Bandwidth <sup>2</sup> (User Selectable)	22 nF as C <sub>OUT</sub> (see Setting Bandwidth section)		40		Hz
Sensor Resonant Frequency			14		kHz
SELF TEST					
ST1 RATEOUT Response <sup>3</sup>	ST1 pin from Logic 0 to 1		–800		mV
ST2 RATEOUT Response	ST2 pin from Logic 0 to 1		+800		mV
Logic 1 Input Voltage	Standard high logic level definition	3.3			V
Logic 0 Input Voltage	Standard low logic level definition			1.7	V
Input Impedance	To common		50		kΩ
TEMPERATURE SENSOR					
V <sub>OUT</sub> at 298K			2.50		V
Max Current Load on Pin	Source to common			50	μA
Scale Factor	Proportional to absolute temperature		8.4		mV/K
OUTPUT DRIVE CAPABILITY					
Output Voltage Swing	I <sub>OUT</sub> = ±100 μA	0.25		V <sub>S</sub> – 0.25	V
Capacitive Load Drive		1000			pF
2.5 V REFERENCE					
Voltage Value			2.5		V
Load Drive to Ground	Source		200		μA
Load Regulation	0 < I <sub>OUT</sub> < 200 μA		5.0		mV/mA
POWER SUPPLY					
Operating Voltage Range		4.75	5.00	5.25	V
Quiescent Supply Current			6.0	8.0	mA
TEMPERATURE RANGE					
Operating Temperature Range		–40		+85	°C

<sup>1</sup> Dynamic range is the maximum full-scale measurement range possible, including output swing range, initial offset, sensitivity, offset drift, and sensitivity drift at 5 V supplies.

<sup>2</sup> Frequency at which response is 3 dB down from dc response with specified compensation capacitor value. Internal pole forming resistor is 180 kΩ. See the Setting Bandwidth section.

<sup>3</sup> Self-test response varies with temperature. See the Self-Test Function section for details.

## ABSOLUTE MAXIMUM RATINGS

Table 2.

Parameter	Rating
Acceleration (Any Axis, Unpowered, 0.5 ms)	2000 g
Acceleration (Any Axis, Powered, 0.5 ms)	2000 g
+V <sub>s</sub>	-0.3 V to +6.0 V
Output Short-Circuit Duration (Any Pin to Common)	Indefinite
Operating Temperature Range	-55°C to +125°C
Storage Temperature	-65°C to +150°C

Stresses above those listed under the Absolute Maximum Ratings may cause permanent damage to the device. This is a stress rating only; functional operation of the device at these or any other conditions above those indicated in the operational section of this specification is not implied. Exposure to absolute maximum rating conditions for extended periods may affect device reliability.

Applications requiring more than 200 cycles to MIL-STD-883 Method 1010 Condition B (-55°C to +125°C) require underfill or other means to achieve this requirement.

Drops onto hard surfaces can cause shocks of greater than 2000 g and exceed the absolute maximum rating of the device. Care should be exercised in handling to avoid damage.

### ESD CAUTION

ESD (electrostatic discharge) sensitive device. Electrostatic charges as high as 4000 V readily accumulate on the human body and test equipment and can discharge without detection. Although this product features proprietary ESD protection circuitry, permanent damage may occur on devices subjected to high energy electrostatic discharges. Therefore, proper ESD precautions are recommended to avoid performance degradation or loss of functionality.



### RATE-SENSITIVE AXIS

This Z-axis rate-sensing device is also called a yaw-rate sensing device. It produces a positive-going output voltage for clockwise rotation about the axis normal to the package top (clockwise when looking down at the package lid).

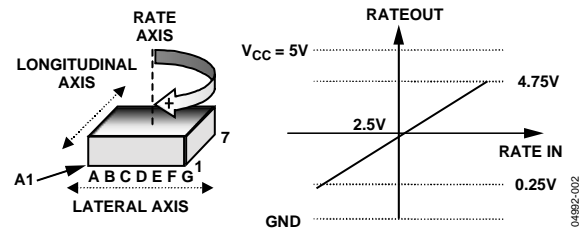

Figure 2. RATEOUT Signal Increases with Clockwise Rotation

## PIN CONFIGURATION AND FUNCTION DESCRIPTIONS

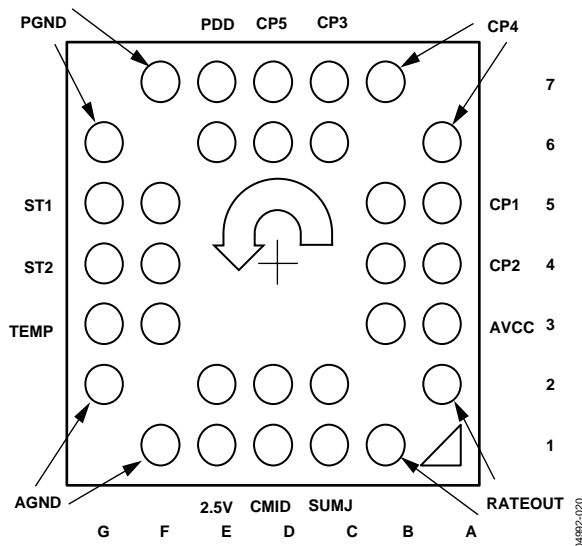

Figure 3. BGA-32 (Bottom View)

Table 3. Pin Function Descriptions

Pin No.	Mnemonic	Description
6D, 7D	CP5	HV Filter Capacitor to Ground – 1 $\mu$ F 20 V minimum
6A, 7B	CP4	Charge Pump Capacitor – 22 nF
6C, 7C	CP3	Charge Pump Capacitor – 22 nF
5A, 5B	CP1	Charge Pump Capacitor – 22 nF
4A, 4B	CP2	Charge Pump Capacitor – 22 nF
3A, 3B	AVCC	+ Analog Supply
1B, 2A	RATEOUT	Rate Signal Output
1C, 2C	SUMJ	Output Amp Summing Junction
1D, 2D	CMID	HF Filter Capacitor – 100 nF
1E, 2E	V2.5	2.5 V Precision Reference
1F, 2G	AGND	Analog Supply Return
3F, 3G	TEMP	Temperature Voltage Output
4F, 4G	ST2	Self-Test for Sensor 2
5F, 5G	ST1	Self-Test for Sensor 1
6G, 7F	PGND	Charge Pump Supply Return
6E, 7E	PDD	+ Charge Pump Supply

## TYPICAL PERFORMANCE CHARACTERISTICS

@ BW = 40 Hz, Typical Vibration Characteristics, 10 g Flat Band, 20 Hz to 2 kHz.

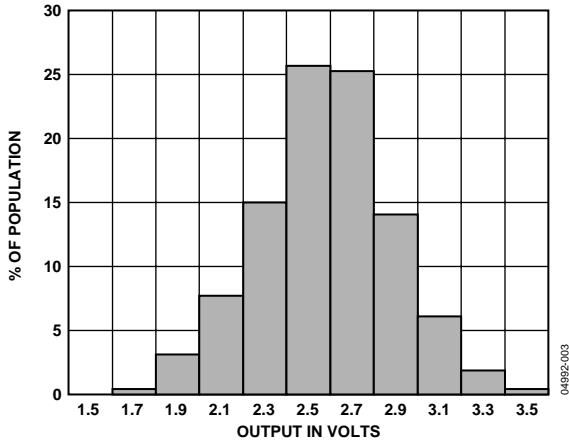

Figure 4. Initial Null Output

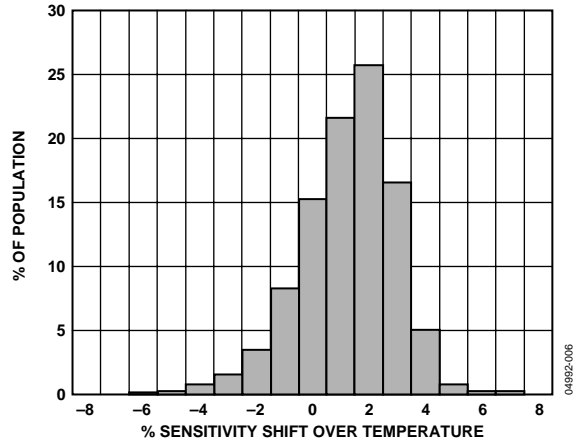

Figure 7. Sensitivity Change Over Temperature

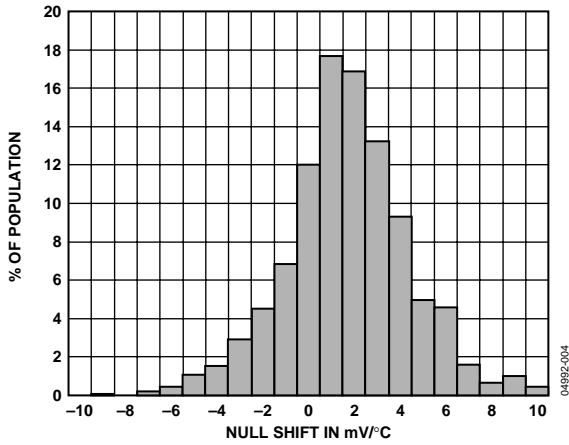

Figure 5. Null Tempco

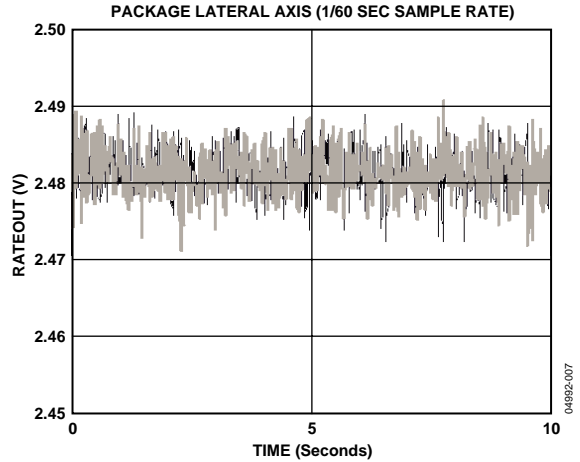

Figure 8. 10 g Random Vibration in Package-Lateral Axis Orientation

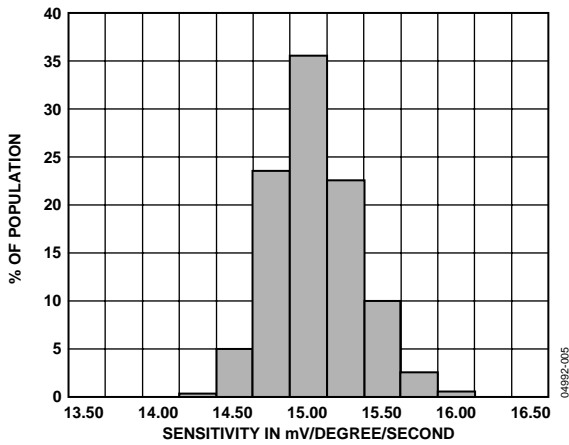

Figure 6. Initial Sensitivity

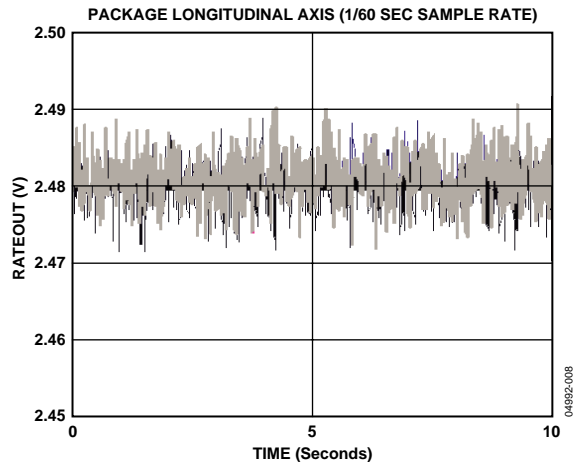

Figure 9. 10 g Random Vibration in Package-Longitudinal Axis Orientation

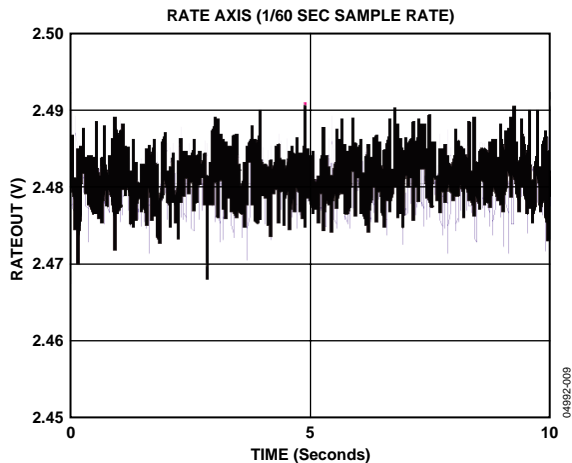

Figure 10. 10 g Random Vibration in Rate Axis Orientation

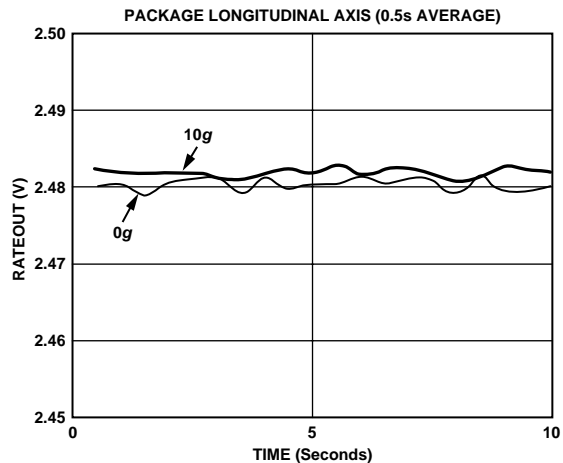

Figure 12. 10 g Random Vibration in Package-Longitudinal Axis Orientation

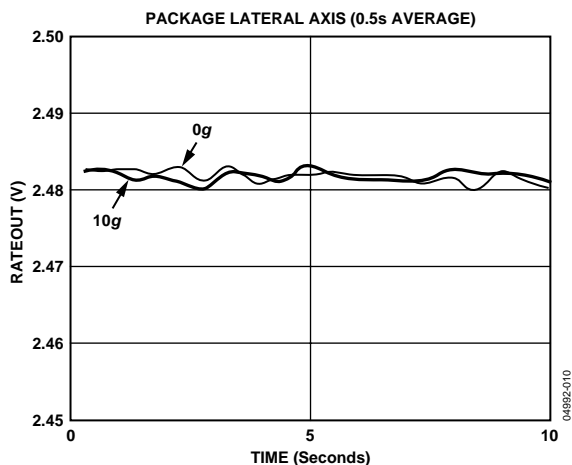

Figure 11. 10 g Random Vibration in Package-Lateral Axis Orientation

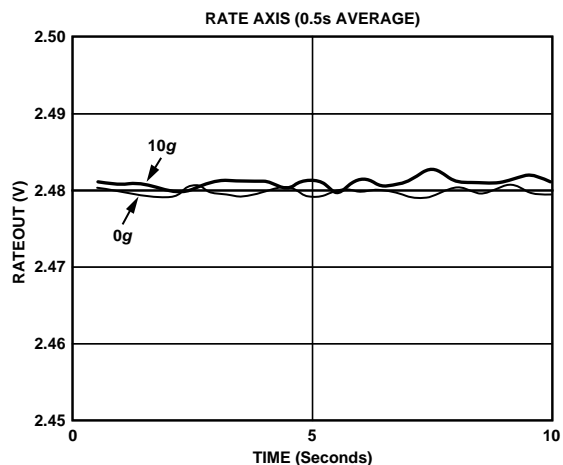

Figure 13. 10 g Random Vibration in Rate Axis Orientation





## SETTING BANDWIDTH

External capacitors  $C_{MID}$  and  $C_{OUT}$  are used in combination with on-chip resistors to create two low-pass filters to limit the bandwidth of the ADXRS401's rate response. The  $-3$  dB frequency set by  $R_{OUT}$  and  $C_{OUT}$  is:

$$f_{OUT} = 1/(2 \times \pi \times R_{OUT} \times C_{OUT})$$

This frequency can be well controlled since  $R_{OUT}$  has been trimmed during manufacturing to be  $180 \text{ k}\Omega \pm 1\%$ . Any external resistor applied between the RATEOUT (1B, 2A) and SUMJ (1C, 2C) pins will result in:

$$R_{OUT} = (180 \text{ k}\Omega \times R_{EXT}) / (180 \text{ k}\Omega + R_{EXT})$$

The  $-3$  dB frequency is set by  $R_{SEN}$  (the parallel combination of  $R_{SEN1}$  and  $R_{SEN2}$ ) at about  $4.5 \text{ k}\Omega$  nominal.  $C_{MID}$  is less well controlled, because  $R_{SEN1}$  and  $R_{SEN2}$  have been used to trim the rate sensitivity during manufacturing and have a  $\pm 35\%$  tolerance. Its primary purpose is to limit the high frequency demodulation artifacts from saturating the final amplifier stage. Thus, this pole of nominally  $400 \text{ Hz}$  @  $0.1 \mu\text{F}$  need not be precise. Lower frequency is preferable, but its variability usually requires it to be about 10 times greater (in order to preserve phase integrity) than the well-controlled output pole. In general, both  $-3$  dB filter frequencies should be set as low as possible to reduce the amplitude of these high frequency artifacts, as well as to reduce the overall system noise.

## INCREASING MEASUREMENT RANGE

To increase the full-scale measurement range of the ADXRS401, place an external resistor between the RATEOUT (1B, 2A) and SUMJ (1C, 2C) pins. This parallels the internal  $R_{OUT}$  resistor that is factory-trimmed to  $180 \text{ k}\Omega$ .

For example, a  $330 \text{ k}\Omega$  external resistor gives approximately  $10 \text{ mV}/^\circ\text{sec}$  sensitivity and a commensurate  $\sim 50\%$  increase in the full-scale range. This is effective for up to a  $4\times$  increase in the full-scale range. (The minimum value of the parallel resistor allowed is  $45 \text{ k}\Omega$ .) Beyond this amount of external sensitivity reduction, the internal circuitry headroom requirements prevent further increase in the linear full-scale output range.

The drawbacks of modifying the full-scale range are the additional output null drift (as much as  $2^\circ/\text{sec}$  over temperature) and the readjustment of the initial null bias. See Null Adjust section and Application Note AN-625 for details.

## TEMPERATURE OUTPUT AND CALIBRATION

It is common practice to temperature-calibrate gyros to improve their overall accuracy. The ADXRS401 has a temperature-proportional voltage output that provides input to such a calibration method. The voltage at TEMP (3F, 3G) is nominally  $2.5 \text{ V}$  at  $27^\circ\text{C}$  and has a PTAT (proportional to absolute temperature) characteristic of  $8.4 \text{ mV}/^\circ\text{C}$ . Note that the TEMP output circuitry is limited to  $50 \mu\text{A}$  source current.

Limiting the bandwidth of the device reduces the flat-band noise during the calibration process, improving the measurement accuracy at each calibration point.

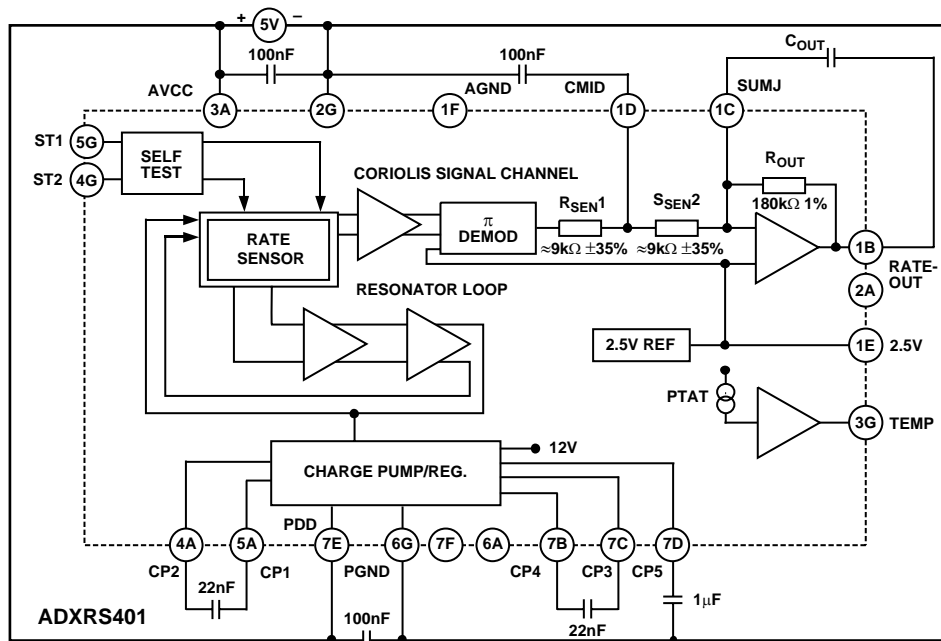

Figure 15. Block Diagram with External Components

# ADXRS401

## USE WITH A SUPPLY-RATIOMETRIC ADC

The ADXRS401's RATEOUT signal is nonratiometric (that is, neither the null voltage nor the rate sensitivity is proportional to the supply). Rather, they are nominally constant for dc supply changes within the 4.75 V to 5.25 V operating range. If the ADXRS401 is used with a supply-ratiometric ADC, the ADXRS401's 2.5 V output can be converted and used to make corrections in software for the supply variations.

## NULL ADJUST

Null adjustment is possible by injecting a suitable current to SUMJ (1C, 2C). Simply add a suitable resistor to either the ground or the positive supply. The nominal 2.5 V null is for a symmetrical swing range at RATEOUT (1B, 2A). In some applications, a nonsymmetrical output swing may be suitable. If a resistor is connected to the positive supply, supply disturbances may reflect some null instability. Avoid digital supply noise, particularly in this case (see the Supply and Common Considerations section).

The resistor value to use is approximately:

$$R_{NULL} = (2.5 \times 180,000) / (V_{NULL0} - V_{NULL1})$$

$V_{NULL0}$  is the unadjusted zero rate output, and  $V_{NULL1}$  is the target null value. If the initial value is below the desired value, the resistor should terminate on common or ground. If it is above the desired value, the resistor should terminate on the 5 V supply. Values typically are in the 1 M $\Omega$  to 5 M $\Omega$  range.

If an external resistor is used across RATEOUT and SUMJ, the parallel equivalent value is substituted into the above equation. Note that the resistor value is an estimate since it assumes  $V_{CC} = 5.0$  V and  $V_{SUMJ} = 2.5$  V.

## SELF-TEST FUNCTION

The ADXRS401 includes a self-test feature that stimulates each of the sensing structures and associated electronics in the same manner, as if subjected to angular rate. It is activated by standard logic high levels applied to inputs ST1 (5F, 5G), ST2 (4F, 4G), or both. ST1 causes the voltage at RATEOUT to change about  $-0.800$  V, and ST2 causes an opposite  $+0.800$  V.

Activating both ST1 and ST2 simultaneously is not damaging. Because ST1 and ST2 are not necessarily closely matched, actuating both simultaneously may result in an apparent null bias shift.

## ACCELERATION SENSITIVITY

The sign convention used is that lateral acceleration is positive in the direction from Pin Column A to Pin Column G of the package. That is, a device has positive sensitivity if its voltage output increases when the row of Pins 2A to 6A are tipped under the row 2G to 6G in the Earth's gravity.

There are two effects of concern: shifts in the static null and induced null noise. Scale factor is not significantly affected until acceleration reaches several hundred meters per second squared.

Vibration rectification for frequencies up to 20 kHz is of the order of  $0.00002(^{\circ}/s)/(m/s^2)$  in the primary axis and  $0.0003(^{\circ}/s)/(m/s^2)^2$  for acceleration applied along a diagonal of the lid. It is not significantly dependent on frequency, and has been verified up to 300 m/s<sup>2</sup> rms.

Linear vibration spectral density near the 14 kHz sensor resonance translates into output noise. In order to have a significant effect, the vibration must be within the angular rate bandwidth (typically  $\pm 40$  Hz of the resonance), so it takes considerable high frequency vibration to have any effect.

Away from the 14 kHz resonance, the effect is not discernible, except for vibration frequencies within the angular rate pass band. The in-band effect can be seen in Figure 17. This is the result of the static g-sensitivity. The specimen used for Figure 17 had a g-sensitivity of 0.15 %/s/g and its total in-band noise degraded from 3 mV rms to 5 mV rms for the specified vibration. The effect of broadband vibration up is shown in Figure 18 and Figure 19.

The output noise of the part falls away in accordance with the output low-pass filter and does not contain any spikes greater than 1% of the low frequency noise. A typical noise spectrum is shown in Figure 16.

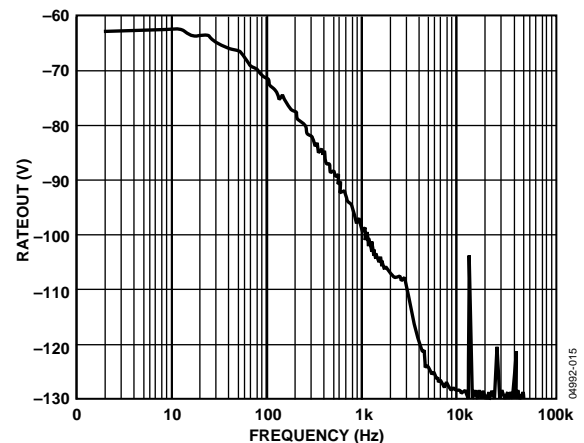

Figure 16. Noise Spectral Density at RATEOUT – BW = 4Hz

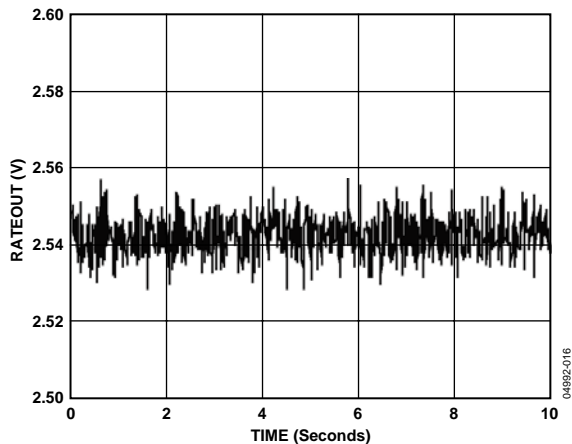

Figure 17. Random Vibration (Lateral) 2 Hz to 40 Hz 3.2 g rms

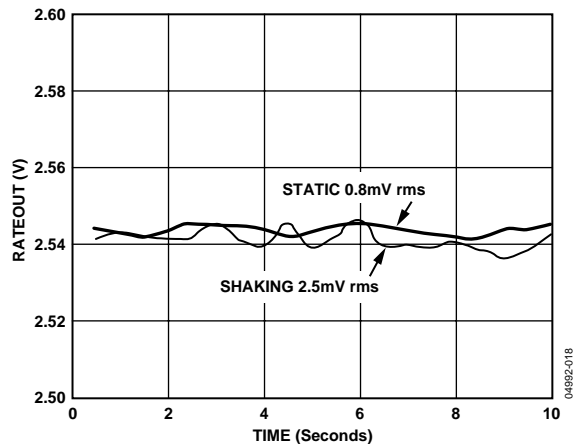

Figure 19. Random Vibration (Lateral) 10 kHz to 20 kHz at 0.01 g/√Hz with 60 Hz Sampling and 0.5 Sec Averaging

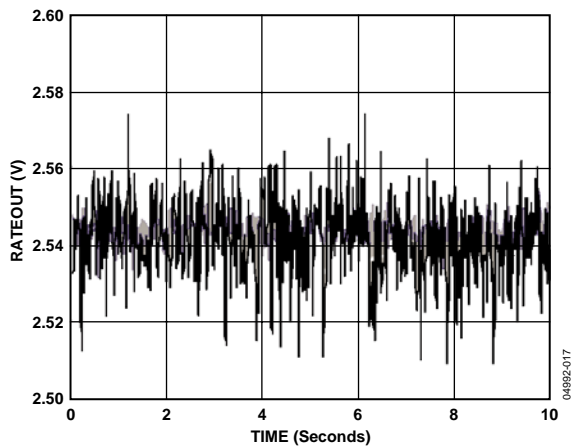

Figure 18. Random Vibration (Lateral) 10 kHz to 20 kHz at 0.01 g/√Hz with 60 Hz Sampling and 0.5 Sec Averaging

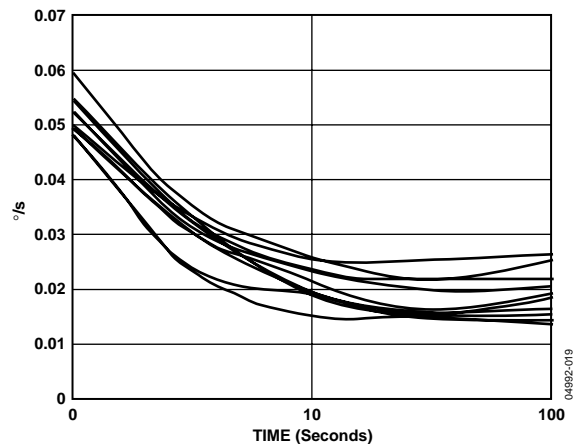

Figure 20. Root Allen Variance vs. Averaging Time

## OUTLINE DIMENSIONS

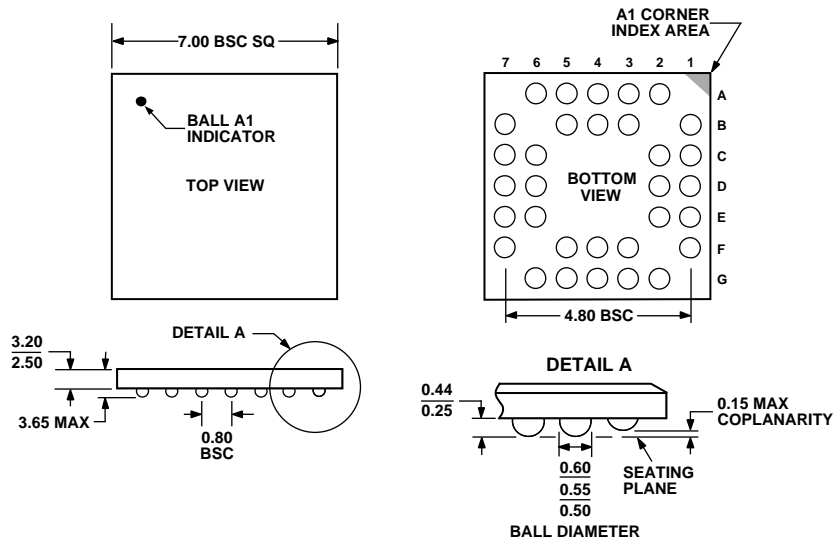

Figure 21. 32-Lead Chip Scale Ball Grid Array [CSPBGA]  
(BC-32)  
Dimensions shown in millimeters

## ORDERING GUIDE

Model	Temperature Range	Package Description	Package Outline
ADXRS401ABG	-40°C to +85°C	32-Lead BGA	BC-32
ADXRS401ABG-REEL	-40°C to +85°C	32-Lead BGA	BC-32
ADXRS401EB		Evaluation Board	